

ANTEA 50E

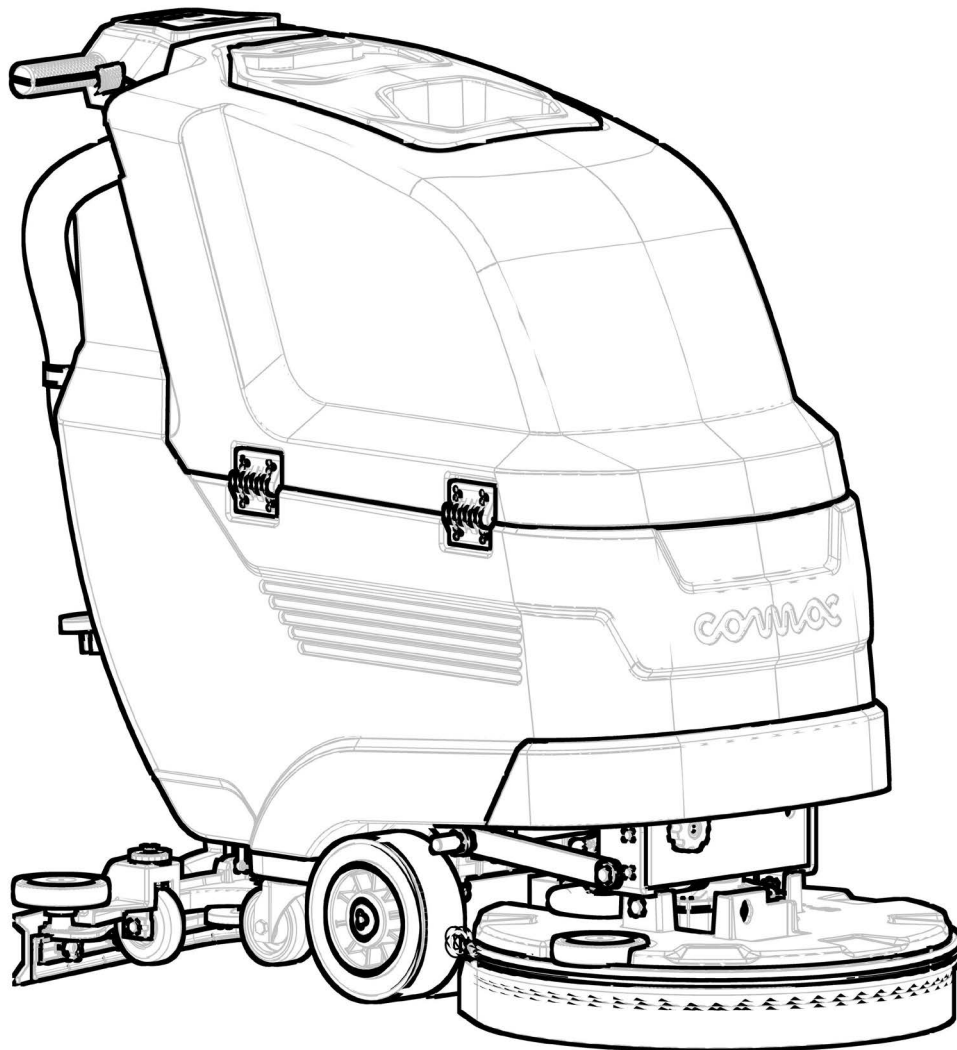

SCRUBBING MACHINES

USE AND MAINTENANCE MANUAL



CONTENTS

| | |
|--|-----------|
| CONTENTS | 3 |
| SAFETY WARNINGS FOR WET/DRY VACUUM CLEANER | 3 |
| DANGER LEVELS..... | 3 |
| CONNECTION TO THE ELECTRICITY GRID..... | 4 |
| USE - EMPLOYMENT..... | 4 |
| TRANSPORT..... | 7 |
| MAINTENANCE..... | 7 |
| ACCESSORIES AND SPARE PARTS..... | 8 |
| CABLE EXTENSION..... | 8 |
| CABLE LENGTH | 8 |
| SYMBOLS USED IN THE MANUAL | 9 |
| PURPOSE AND CONTENT OF THE MANUAL | 9 |
| TARGET GROUP | 9 |
| STORING THE USE AND MAINTENANCE MANUAL | 9 |
| ON DELIVERY OF THE APPLIANCE | 9 |
| INTRODUCTORY COMMENT | 9 |
| IDENTIFICATION DATA | 9 |
| TECHNICAL DESCRIPTION | 9 |
| INTENDED USE | 9 |
| SAFETY | 9 |
| SERIAL NUMBER PLATE | 9 |
| TECHNICAL DATA | 9 |
| SYMBOLS USED ON THE APPLIANCE | 10 |
| SYMBOLS PRESENT ON THE REGISTRATION PLATE..... | 10 |
| SYMBOLS PRINTED ON THE APPLIANCE..... | 10 |
| LABELS PRESENT ON THE APPLIANCE..... | 10 |
| SYMBOLS USED ON THE INSTRUMENT PANEL..... | 10 |
| PREPARING THE APPLIANCE | 10 |
| HANDLING THE PACKED APPLIANCE..... | 10 |
| HOW TO UNPACK THE APPLIANCE..... | 10 |
| HOW TO TRANSPORT THE APPLIANCE..... | 10 |
| COMPONENT POSITIONING..... | 10 |
| APPLIANCE SAFETY..... | 11 |
| HOUR METER..... | 11 |
| ASSEMBLING THE BRUSH..... | 11 |
| ASSEMBLING THE SPLASH GUARD BRUSH HEAD..... | 11 |
| ASSEMBLING THE SQUEEGEE BODY..... | 11 |
| FILLING THE SOLUTION TANK WITH WATER..... | 11 |
| DETERGENT SOLUTION..... | 12 |
| PREPARING TO WORK | 12 |
| WORK | 12 |
| STARTING WORK (B versions)..... | 12 |
| SCRUBBING WITH DRYING..... | 12 |
| SCRUBBING WITHOUT DRYING..... | 12 |
| DRYING..... | 13 |
| REGULATING THE DETERGENT SOLUTION..... | 13 |
| REGULATING THE FORWARD SPEED..... | 13 |
| OVERFLOW DEVICE..... | 13 |
| AT THE END OF THE WORK | 13 |
| MAINTENANCE | 13 |
| RECOMMENDED MAINTENANCE OPERATIONS..... | 13 |
| CHECKING AND CLEANING THE RECOVERY TANK..... | 14 |
| CHECKING AND CLEANING THE SOLUTION TANK CAP-FILTER..... | 14 |
| CHECKING AND CLEANING THE SQUEEGEE BODY..... | 14 |
| ADJUSTING THE SQUEEGEE BODY..... | 14 |
| CHECKING AND MAINTAINING THE RECOVERY TANK FILTER-FLOAT..... | 15 |
| CHECKING AND CLEANING THE SOLUTION TANK..... | 15 |
| CHECKING AND MAINTAINING THE BRUSH..... | 15 |
| CHECKING AND CLEANING THE VACUUM HOSE..... | 16 |
| CLEANING THE WATER SYSTEM..... | 16 |
| TROUBLESHOOTING | 16 |
| DISPOSAL | 17 |
| CHOOSING AND USING BRUSHES | 17 |
| EC DECLARATION OF CONFORMITY | 17 |

SAFETY WARNINGS FOR WET/DRY VACUUM CLEANER



Before using the appliance for the first time, read and comply with these safety warnings. Keep these safety warnings for consultation in the future or to hand them over to successive owners.

- Before commissioning, read the appliance's user manual.
- The warning plates on the appliance provide important instructions for its safe use.
- Always comply with both the directions on the instructions, as well as current safety standards.
- Keep the packing film out of the reach of children. Risk of asphyxiation!

DANGER LEVELS



DANGER: Indicates an imminent danger that could cause serious injury or death.



WARNING: Indicates a probable dangerous situation that could cause serious injury or death.



CAUTION: Indicates a probable dangerous situation that could cause minor injuries.



ATTENTION: Indicates a probable dangerous situation that could damage objects.

CONNECTION TO THE ELECTRICITY GRID

DANGER:

- To reduce the risk of fire, electric shocks or injury, please read and follow the safety instructions and warning indications before using. This appliance has been designed to be safe when it is used for cleaning in the manner specified. If damage to electrical or mechanical components is found, the appliance must be repaired at the relative authorised service centre or else at the manufacturer before use, in order to prevent further damage to the appliance or physical injury to the user.
- Before connecting the appliance to the electricity socket, make sure the electrical information on the plate corresponds to that of the mains supply. **The appliance must only be powered with alternating current and voltage equal to that shown on the serial number plate.**
- The power supply cable outlet must have an earth connection in compliance with the regulatory standards.
- The cable for connecting to the mains that is supplied with the appliance should be used for the above-mentioned appliance and not for other appliances.
- Before using, check for any damage on the connection cable and on the power plug.
- If the power cable is damaged it should be replaced by the manufacturer or by its technical service centre or in any event by a person with similar qualifications in order to prevent any risks.
- Connect the appliance only to an electrical connection installed by an electrical installer in conformity with IEC 60364-1.
- Never touch the power plug with wet hands.
- Make sure that the cable to the mains or the extension cable have not been damaged by having been walked on, crushed, pulled or the like. Protect the cable from heat and from contact with oils or sharp edges.
- Make sure that the cable connected to the mains or the extension cable have not been damaged when the scrubbing brush head is used, passing over it with the brushes or rotating discs.
- Regularly check that the cable connecting to the mains is not damaged, for example with signs of ageing or cracks. If damage is found, the cable should be replaced before using the appliance again.
- Protection against splashes of water and the mechanical strength need to be ensured also after any replacement of the joints of the power cable or the extension cable.
- Do not clean the appliance with a hose or a jet of high pressure water (risk of short-circuit or other electrical faults).

ATTENTION:

- The procedure causes short-term reduction in voltage.
- In unfavourable grid conditions the other appliances could be damaged.
- This damage could occur if the grid impedance is less than 0.15Ω.

USE - EMPLOYMENT

DANGER:

- Never collect gases, explosive/inflammable liquids or powders, nor acids and solvents! These include gasoline, paint thinners and fuel oil (which, when mixed with the vacuum air, can form explosive vapours or mixtures), and also non-diluted acids and solvents, acetones, aluminium and magnesium powders. These substances may also corrode the materials used to construct

the appliance.

- If the appliance is used in dangerous areas (e.g. petrol stations), the relative safety standards must be observed. The appliance must never be used in environments with a potentially explosive atmosphere.
- In order to avoid short-circuits when working in the vicinity of electrical components, do the following: avoid the use of non-insulated tools; do not place or allow metallic objects to fall upon the electrically powered components; remove any rings, watches and/or clothing with metallic parts that might come into contact with the electrically powered components.
- Never use with a damaged cable or plug. When removing from an electrical socket, pull the plug and not the cable. Do not handle the plug or the vacuum cleaner with wet hands. Deactivate all the controls before connecting or disconnecting from the electrical socket.
- Do not pull or transport the appliance by the cable, do not use the cable as a handle, do not close a door on the cable, and do not pull the cable around edges or sharp corners. Do not pass the vacuum cleaner over the cable. Keep the cable away from hot surfaces.
- The appliance must not be used or kept outdoors, in damp conditions or directly exposed to rain.
- The storage temperature must be between -25°C and $+55^{\circ}\text{C}$.
- Conditions of use: ambient temperature between 0°C and 40°C with a relative humidity between 30 and 95%. The vacuum cleaner has been developed only for dry cleaning and it should not be used or kept outdoors in moist conditions.
- Before using, make sure the appliance and the work equipment and in particular the extension cable are in a good condition. If there is any damage, immediately pull out the power plug from the mains socket, the appliance should not be used.
- When the appliance is used in dangerous situations (for example filling stations) the relative safety regulations must be followed. It is forbidden to use the appliance in areas with a high risk of explosion.
- Certain substances can form explosive vapours and mixtures together with intake air.
- Never vacuum the following substances:
 - ◆ Explosive or inflammable gases, liquids and powders (reactive powders).
 - ◆ Reactive metal powders (for example aluminium, magnesium, zinc) together with strongly alkaline detergents and acids.
 - ◆ Acids and alkalines in their purest state.
 - ◆ Organic solutions (for example gasoline, paint thinners, acetone or gasoline).

 **WARNING:**

- The appliance must be only used by authorized, trained personnel.
- Do not use the appliance on surfaces with an inclination greater than the one shown on the registration plate.
- The appliance is not suitable for cleaning rough or uneven floors. Do not use the appliance on slopes.
- Adapt the speed to the adhesion conditions.
- Do not use to vacuum flammable or combustible liquids like gasoline, or use in areas where they may be present.
- Do not vacuum anything that is burning or smouldering, like cigarettes, matches or glowing embers.
- Children must be supervised to make sure they do not play with the appliance.
- Children should not do any cleaning or maintenance that is the responsibility of the user without supervision.
- This appliance should only be used in closed areas.

- Never leave the appliance unattended when it is connected to the mains socket. Take the plug out of the socket when not used and before any maintenance.
- Burning or smouldering objects.
- In low temperatures, the appliances should not be used outdoors.

**CAUTION:**

- Carefully read the labels on the appliance. Do not cover them for any reason and replace them immediately if they become damaged.
- The appliance must always be stored and used in an enclosed space or under cover.
- The appliance must not be used or kept outdoors, in damp conditions or directly exposed to rain.
- The appliance does not cause harmful vibrations.
- To prevent any unauthorised use of the appliance, the power supply must be disconnected, the appliance must be switched off using the main switch, and the plug of the power cable must be removed from the mains socket.
- Children must be supervised to ensure they do not play with the device.
- When using the appliance, pay attention to other people and especially to children.
- The appliance must only be powered with a voltage and a frequency equal to that shown on the serial number plate.
- The device must only be kept in closed areas.
- Always use the appliance in compliance with its intended use, taking into consideration local conditions and looking out for the presence of others, especially children, when working.
- Never leave the appliance unattended until it has been switched off and the plug has been taken out of the mains socket.
- When left unattended, the appliance must be protected from unintentional movements.
- Always wear suitable protective gloves when working with the appliance.
- The appliance should only be used by people trained in its use and who have shown that they know how to use the appliance and have been expressly authorised to do so.
- Do not place any liquid containers on the appliance.
- In the event of a fire, use a powder extinguisher. Do not use water.

**ATTENTION:**

- When using the appliance keep an eye out for people and objects.
- Be careful to avoid collisions with shelving or scaffolding, above all if there is a risk of objects falling from heights.
- Do not place any liquid containers on the appliance.
- The operating temperature of the appliance should be between 0°C and +40°C.
- The machine must be stored at a temperature between 0 °C and +40 °C.
- The humidity level must be between 30% and 95%.
- When using detergents to clean the flooring, always follow the instructions and respect the warnings indicated on the containers' labels.
- Always use appropriate gloves and protective equipment when handling the detergents used to clean the floor.
- Do not use the appliance as a means of transport.
- Avoid using the brushes while the appliance is standing still, so as not to damage the floor.
- Never tamper with the appliance's protection devices for any reason; always follow the routine maintenance instructions to the letter.
- Do not allow any objects get into the appliance's openings. Do not use the appliance if the

openings are obstructed.

- Keep the appliance's openings free of any dust, lint, hairs, or any other foreign materials that could reduce the airflow.
- Do not remove or alter any labels affixed to the appliance.
- This appliance has not been approved for use on public streets or roadways.
- Use caution when moving the appliance in temperatures below freezing. The water contained in the water recovery tank or in the pipes could freeze and seriously damage the appliance.
- Use only brushes and pad holders supplied with the appliance or those specified in the Operator Manual. The use of other brushes or felt pads could compromise the machine's safety conditions.
- If any issues are encountered while using the appliance, make sure that these are not due to a lack of proper maintenance. Otherwise, request the intervention of authorized personnel or an Authorized service centre.
- If any parts need to be replaced, always request ORIGINAL spare parts from an authorized Dealer or Retailer.
- In order to ensure the machine's safety and proper functionality, always have the scheduled maintenance interventions (specified in the appropriate section of this Manual) performed by authorized personnel or by an authorized Service Centre.
- Do not wash the appliance with direct water jets or with pressurized water, or with corrosive substances.
- Have the appliance checked by an authorized technical assistance centre every year.
- When disposing of consumable materials, observe the laws and regulations in force. When, after years of valuable work, your appliance needs to be decommissioned, dispose of the materials contained in it appropriately, bearing in mind that the appliance is made of fully recyclable materials.

TRANSPORT

WARNING:

- Do not tilt the appliance if there is any liquid in the tanks.
- When transporting the appliance make sure that it is in a stable and secure position.

MAINTENANCE

DANGER:

- Before cleaning and carrying out maintenance on the appliance and before replacing any components, switch off the appliance and pull out the power plug from the mains socket.
- Repairs should only be carried out by authorised service centres or by personnel who are experts in this field and who are familiar with all the current safety norms.
- Observe the safety check as per local provisions for commercial appliances.
- Do not work underneath the raised machine without adequate fixed safety supports.

WARNING:

- Read all the relevant instructions carefully before performing any maintenance/repair operations.
- If the appliance does not work properly, check this is not caused by failure to carry out routine maintenance. Otherwise, ask for intervention of the authorized technical assistance centre.
- Restore all electrical connections after any maintenance interventions.
- Always protect the appliance against sunlight, rain, and other bad weather conditions, both while it is stationary and when it is operating. Store the appliance in a dry, sheltered place:

this appliance is only designed for dry use, and must not be used or stored outdoors in damp conditions.

ACCESSORIES AND SPARE PARTS



CAUTION:

Only use accessories and spare parts that have been authorised by the manufacturer. Original accessories and spare parts ensure the appliance can be used safely and without any fault.

CABLE EXTENSION



CAUTION:

| CABLE LENGTH | CABLE SECTION | |
|-----------------|--------------------|--------------------|
| | <16A | <25A |
| Up to 20m | 1.5mm ² | 2.5mm ² |
| From 20m to 50m | 2.5mm ² | 4.0mm ² |

Only use the materials expressly recommended by the manufacturer as cable extensions (contact an authorised retailer) or else high quality models. When using an extension, respect its minimum cross-section.

The descriptions contained in this document are not binding. The company therefore reserves the right to make any modifications at any time to elements, details, or accessory supply, as considered necessary for reasons of improvement or manufacturing/commercial requirements. The reproduction, even partial, of the text and drawings contained in this document is prohibited by law.

The company reserves the right to make any technical and/or supply modifications. The images are shown as reference only and are not binding as to the actual design and/or equipment.

SYMBOLS USED IN THE MANUAL



Open book symbol with an "i":
Indicates the need to consult the instruction manual.



Open book symbol:
Tells the operator to read the manual before using the appliance.



Covered place symbol:
the operations preceded by this symbol must always be carried out in a dry, covered area.



Warning symbol:
Carefully read the sections preceded by this symbol meticulously following the instructions indicated for the safety of the operator and the device.



Protective gloves symbol:
Indicates that the operator should always wear protective gloves, to avoid the risk of serious injury to his hands from sharp objects.



Protective gloves symbol:
Indicates that the operator should always wear protective gloves, to avoid the risk of serious injury to his hands from chemical agents.



Warning symbol that the carriage is moving:
Indicates that the packed product should be handled with suitable carriages that conform to legal requirements.



Information symbol:
Indicates additional information for the operator, to improve the use of the device.



Disposal symbol:
Carefully read the sections marked with this symbol for disposing of the appliance.



Recycling symbol:
Tells the operator to carry out the operations in compliance with environmental regulations in force in the place where the appliance is being used.

PURPOSE AND CONTENT OF THE MANUAL

The aim of this manual is to provide customers with all the information needed to use the appliance in the safest, most appropriate and most autonomous way. It includes information concerning technical aspects, safety, operation, appliance downtime, maintenance, spare parts and scrapping. Operators and qualified technicians must read the instructions in this manual carefully before carrying out any operation on the appliance. If in doubt about the correct interpretation of instructions, contact your nearest Customer Service Centre to obtain the necessary clarifications.

TARGET GROUP

This manual is aimed at operators and qualified technicians responsible for appliance maintenance. Operators must not perform operations that should be carried out by qualified technicians. The manufacturer is not liable for damages resulting from failure to comply with this veto.

STORING THE USE AND MAINTENANCE MANUAL

The Use and Maintenance Manual must be stored in its special pouch close to the appliance, protected from liquids and anything else that could compromise its legibility.

ON DELIVERY OF THE APPLIANCE

When the machine is delivered to the customer, an immediate check must be performed to ensure all the material mentioned in the shipping documents has been received, in addition to verifying that the equipment has not been damaged during transportation. If this is the case, the carrier must ascertain the extent of the damage at once, informing our customer service office. It is only by prompt action of this type that the missing material can be obtained, and compensation for damage successfully claimed.

INTRODUCTORY COMMENT

Any type of equipment can only work properly and effectively if used correctly and kept in full working order by performing the maintenance operations described in the attached documentation. You should therefore read this instruction manual carefully, consulting it again if issues arise while using the machine. If necessary, remember that our assistance service (organised in collaboration with our dealers) is always available for advice or direct intervention.

IDENTIFICATION DATA

For technical assistance or to request replacement parts, always give the model, the version and the serial number (written on the relevant plate).

TECHNICAL DESCRIPTION

The ANTEA 50E is a scrubbing machine that cleans a wide range of flooring and dirt types by means of the mechanical action of the discoidal brush and the chemical action of a water-detergent solution. It is capable of cleaning a wide range of floors and types of dirt, moving forward collecting the dirt that has been removed and the detergent solution that has not been absorbed by the floor. **The appliance must only be used for this purpose.**

INTENDED USE

This scrubbing machine was designed and built for the cleaning (scrubbing and drying) of smooth, compact flooring in the commercial, residential and industrial sectors by a qualified operator in proven safety conditions. The scrubbing machine is not suitable for cleaning rugs or carpet floors. The appliance is only suitable for use in indoor - or at least covered - areas.

ATTENTION: the appliance is not suitable for use in the rain, or under jets of water.

IT IS FORBIDDEN to use the appliance for picking up dangerous dusts or inflammable liquids in places with an explosive atmosphere. In addition, it is not suitable as a means of transport for people or objects.

SAFETY

Operator cooperation is paramount for accident prevention. No accident prevention programme can be effective without the full co-operation of the operator who is directly responsible for machine operation. The majority of occupational accidents that happen both in the workplace or whilst moving are caused by failure to respect the most basic safety rules. An attentive, careful operator is most effective guarantee against accidents and is fundamental in order to implement any prevention programme.

SERIAL NUMBER PLATE

The serial number plate is located inside the device, on the lower part of the recovery tank, and indicates the general characteristics of the device and in particular the appliance's serial number. The serial number is a very important piece of information and should always be provided together with any request for assistance or to purchase spare parts.

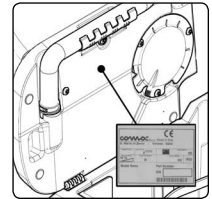

| TECHNICAL DATA | S.I. | ANTEA 50E |
|--|--------------------|-----------|
| Machine's electrical characteristics (voltage - frequency) | V - Hz | 220 - 50 |
| Rated power of the device | W | 825 |
| Working width | mm | 508 |
| Working capacity up to | sq.m./h | 1250 |
| Maximum gradient with full load | % | 2 |
| Squeegee width (standard) | mm | 700 |
| Squeegee width (optional) | mm | 800 |
| Disc brush (number / diameter) | No. / Ø mm | 1 / 508 |
| Disc brush rotations | rpm | 140 |
| Brush head motor (Rated power) | W | 375 |
| Maximum weight exerted upon the brush head body | kg | 23 |
| Vacuum motor (Rated power) | W | 450 |
| Suction vacuum (hole Ø 0 measured at the motor) | mmH ₂ O | 1215 |
| Solution tank capacity | l | 40 |
| Recovery tank capacity | l | 60 |
| Appliance length | mm | 1177 |
| Appliance height | mm | 992 |
| Appliance width (without squeegee) | mm | 591 |
| Device width (with squeegee) | mm | 700 |
| Appliance weight (tanks empty) | kg | 80 |
| Gross weight of the device ready for use | kg | 120 |
| Sound pressure level (ISO 11201) - L pA | dB (A) | <70 |
| Uncertainty KpA | dB (A) | 1.5 |
| Hand vibration level (ISO 5349) | m/s ² | < 2.5 |
| Vibration measurement uncertainty | | 1.5% |

ANTEA50 E

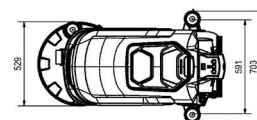
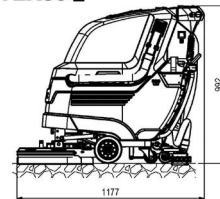



SYMBOLS USED ON THE APPLIANCE

SYMBOLS PRESENT ON THE REGISTRATION PLATE

X%
 **Maximum gradient symbol:**
 Used on the registration plate of the device, to indicate the maximum gradient that can be safely handled by the device in work mode.

SYMBOLS PRINTED ON THE APPLIANCE

 **Symbol for tank discharge:**
 Used on the rear of the device to indicate the position of the solution tank drainage cap.

 **Brush head body control symbol:**
 Used on the rear of the appliance, to indicate the position of the brush head control pedal.

 **Tap position symbol:**
 Used on the rear of the appliance, to indicate the position of the detergent solution control tap.

 **Cap/filter position symbol:**
 Used on the rear of the device to indicate the position of the solution tank cap/filter.

 **Symbol of maximum temperature for filling the solution tank:**
 Used on the side of the device, to indicate the maximum temperature of the water for filling the solution tank safely.

LABELS PRESENT ON THE APPLIANCE

 **Symbol for squeegee in "WORK" position:**
 This is used in the rear of the machine to indicate where the squeegee control lever needs to be positioned for work mode.

 **Symbol for squeegee in "IDLE" position:**
 This is used in the rear of the machine to indicate where the squeegee control lever needs to be positioned for idle mode.

 **Detergent flow control symbol.**
 Used on the rear of the device to indicate the position of the detergent solution flow adjustment lever.

 **Symbol for work speed regulation (B versions):**
 Used on the brush head body to indicate the knob for adjusting the working speed of the device in the version without traction.

 **Squeegee body vacuum hose position:**
 Used on the back of the appliance to identify the correct position for the squeegee body's vacuum hose. The tube must be positioned behind the squeegee body's lifting chain.

 **Do not approach the appliance when the brush is moving:**
 It is used on the front of the brush head and it is forbidden to approach the appliance when the brush is moving. Moreover, remember that if you want to carry out any maintenance you need to first disconnect the power cable.

 **Attention, danger of electrical shock:**
 It is used in the appliance to indicate the danger of an electrical shock.

 **Power supply voltage:**
 It is used to indicate the appliance's voltage.

 **Earthing:**
 It is used in the appliance to indicate the position of the electric earthing cable.

 **Obligatory grounding:**
 Used to indicate that it is compulsory to ground the appliance's plug.

 **Attention, read the manual before use:**
 Used to indicate that the use and maintenance manual must be read before using the appliance.

SYMBOLS USED ON THE INSTRUMENT PANEL

ON
 **Main switch symbol:**
 This is used on the back of the appliance to indicate the main switch.

OFF
 **Symbol of vacuum motor control switch:**
 Used on the instrument panel to indicate the vacuum motor control switch.

 **Brush head motor thermal circuit-breaker symbol:**
 Used on the lower part of the instrument panel to indicate the brush head motor thermal circuit-breaker.

PREPARING THE APPLIANCE

HANDLING THE PACKED APPLIANCE

Since the packaging elements (plastic bags, staples, etc.) are a potential source of danger, they should not be left within the reach of children, disabled persons, etc.
 The gross weight of the appliance, including packaging, is 95 Kg. The overall dimensions of the package are: A=610mm B=1250mm C=1135mm

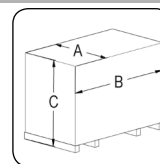

 **ATTENTION:** it is recommended that all the packaging components be kept for any future transportation of the appliance.

 **ATTENTION:** move the packaged product with handling equipment that complies with legal requirements regarding size and mass of the packaging.

HOW TO UNPACK THE APPLIANCE

The appliance is contained in specific packaging; to remove the appliance from the packaging proceed as follows:

1. Place the lower part of the outer packaging in contact with the floor.

 **ATTENTION:** Use the pictograms printed on the box as reference.

2. Remove the outer package.

 **ATTENTION:** these operations must be carried out using protective gloves to avoid any possible contact with the edges or tips of metal objects.

3. Raise the brush head body and press the brush head control pedal (1) (on the rear of the device) downwards (Fig.1).

4. Raise the squeegee body and turn the squeegee control lever (2) in the direction of the arrow in (Fig.2). The lever is located on the back of the device.

5. The device is fixed to the pallet by means of wedges (3) that block the wheels and brush head (Fig.3). Remove the wedges.

6. Using a chute, bring the device down from the pallet, pushing it backwards.

 **ATTENTION:** Do not fit the brush and the rear squeegee body before unloading the device, and avoid any violent jolts to the brush head and the squeegee support.

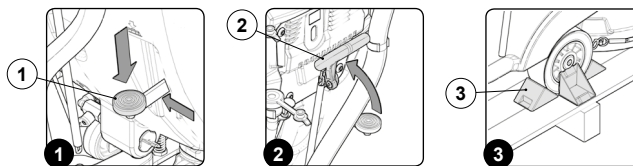

HOW TO TRANSPORT THE APPLIANCE

To transport the machine, proceed as follows:

1. Check that the solution tank and recovery tank are empty. If they are not, empty them (read the paragraph "CHECKING AND CLEANING THE RECOVERY TANK" or read the paragraph "CHECKING AND CLEANING THE SOLUTION TANK").

2. Make sure the appliance is off, if not set the main switch (1) to "OFF - 0" (Fig.1).

3. Disconnect the plug on the appliance's power cable from the mains socket (Fig.2).

4. Using a chute, slide the machine onto the pallet.

5. Secure the device to the pallet using the wedges.

 **ATTENTION:** for transportation without a pallet, secure the device according to the directives in force in the country of use so that it does not slide or tip over.

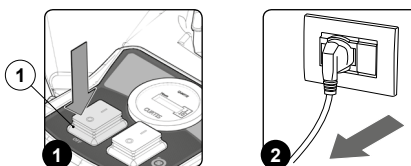

COMPONENT POSITIONING

The basic components of the appliance are as follows:

1. Knob for adjusting the appliance's work speed (Fig.1).

2. Recovery tank outlet pipe (Fig.2).

3. Handle for raising the recovery tank (Fig.2).

4. Solution tank cap/measuring device (Fig.3).

5. Tube for quick filling of the solution tank (Fig.3).

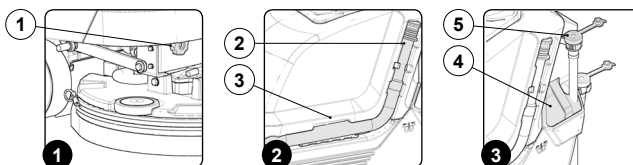

6. Tube for solution tank level/drainage (Fig.4).

7. Handle for raising the squeegee body (Fig.4).

8. Rod for adjusting the detergent solution flow (Fig.4).

9. Tap control lever (Fig.5).

10. Squeegee body vacuum hose (Fig.5).

11. Brush head control pedal (Fig.6).

12. Solution tank cap/filter (Fig.6).

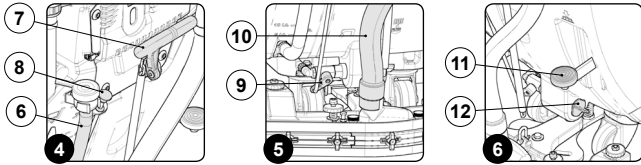

- 13. Hour meter display (Fig.7).
- 14. Main switch (Fig.7).
- 15. Vacuum motor control switch (Fig.7).
- 16. Dead man's lever (Fig.7).
- 17. Brush head motor thermal circuit-breaker (Fig.7).
- 18. Recovery tank cover (Fig.8).
- 19. Storage compartment (Fig.8).

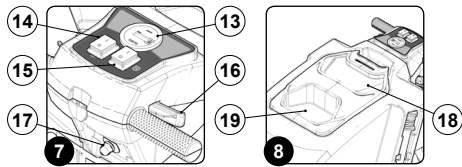

APPLIANCE SAFETY

The stages for making the appliance safe, and thereby allowing all the operations to be carried out in complete safety, are as follows:

1. Make sure the appliance is off, if not set the main switch (1) to "OFF - 0" (Fig.1).
2. Disconnect the plug on the appliance's power cable from the mains socket (Fig.2).
3. Bring the brush head into contact with the floor, using the brush head control pedal (2) (Fig.3).
4. Bring the squeegee into contact with the floor, turn the squeegee control lever (3) counter-clockwise (Fig.4).

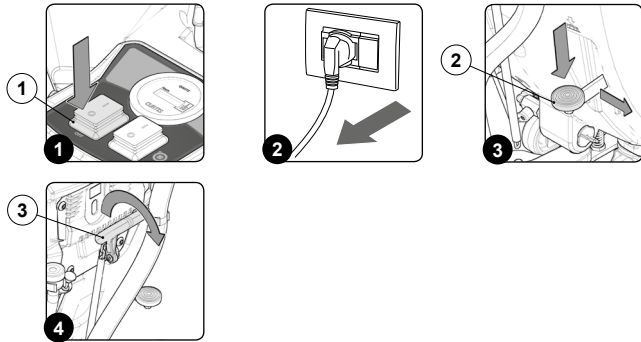

HOUR METER

On the upper part of the display, you will see the total operating time. The line visualised shows the operating hours; the number consists of five figures, plus one figure after the point "." to show the tenth of an hour.

ASSEMBLING THE BRUSH

For packaging reasons, the brush is supplied disassembled from the device. To assemble it on the brush head body, proceed as follows:

1. Take all necessary steps to ensure that the device is in a safe condition (see "MACHINE SAFETY").
2. Raise the brush head body off the floor and press the brush head control pedal (1) on the rear of the device (Fig.1).

ATTENTION: these operations must be carried out using protective gloves to avoid any possible contact with the edges or tips of metal objects.

3. If the splash guard is present, release the retainer spring (2) on the brush head splash guards (Fig.2).
4. Remove the retainer blade (3) and the splash guard (4) (Fig.3).
5. With the brush head UP, insert the brush in the plate housing underneath the brush head, turning it until the three buttons engage with the niches on the plate itself. Turn until the pin is pushed towards the coupling spring and is locked into place. The photo (Fig.4) shows the rotation direction for brush coupling.
6. Replace the splash guard, inserting first the rear left part and then the right part. Remember to fix it to the brush head using the retainer blade.
7. Fix the retainer blade to the brush head with the aid of the spring.

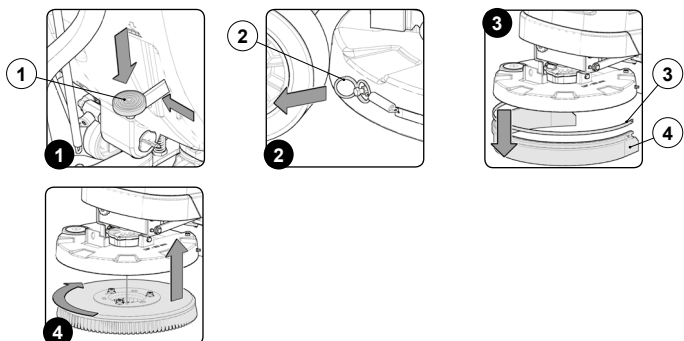

ASSEMBLING THE SPLASH GUARD BRUSH HEAD

For packaging reasons, the brush head splash guard is supplied disassembled from the device, and must be assembled on the brush head body as follows:

1. Take all necessary steps to ensure that the device is in a safe condition (see "MACHINE SAFETY").
2. Raise the brush head body off the floor and press the brush head control pedal (1) on the rear of the device (Fig.1).

ATTENTION: these operations must be carried out using protective gloves to avoid any possible contact with the edges or tips of metal objects.

3. Release the retainer spring (2) on the brush head splash guards (Fig.2).
4. Remove the retainer blade (3) (Fig.3).
5. Fit the splash guard (Fig.4), inserting first the left part and then the right part. Remember to fix it to the brush head using the retainer blade.
6. Fix the retainer blade to the brush head with the aid of the spring.

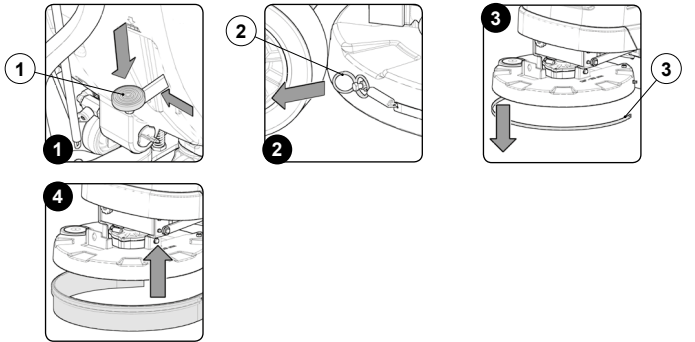

ASSEMBLING THE SQUEEGEE BODY

For packaging reasons, the squeegee body is supplied disassembled from the device, and must be assembled on the squeegee support as follows:

1. Take all necessary steps to ensure that the device is in a safe condition (see "MACHINE SAFETY").

ATTENTION: these operations must be carried out using protective gloves to avoid any possible contact with the edges or tips of metal objects.

2. Make sure the squeegee body support is raised off the floor. If it isn't, turn the squeegee control lever (1) on the back of the machine in the direction shown by the arrow (Fig.1).
3. Unscrew the knobs (2) in the squeegee body pre-assembly (Fig.2).
4. First insert the left pin (3) on the squeegee body into the left slit (4) in the squeegee support (Fig.3), making sure that the washer and spring adhere to the top of the squeegee support.

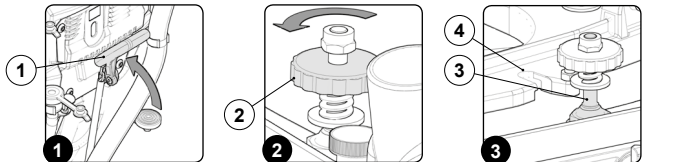

5. Insert the right pin (5) on the squeegee body into the right slit (6) in the squeegee support (Fig.4), making sure that the washer and spring adhere to the top of the squeegee support.

6. Tighten the knobs (2), ensuring that the washer and spring adhere to the top part of the squeegee support (Fig.5).
7. Insert the vacuum tube (7) in the sleeve (8) in the squeegee body (Fig.6).

ATTENTION: the squeegee has been adjusted beforehand, nevertheless if it is necessary read the section "ADJUSTING THE SQUEEGEE BODY".

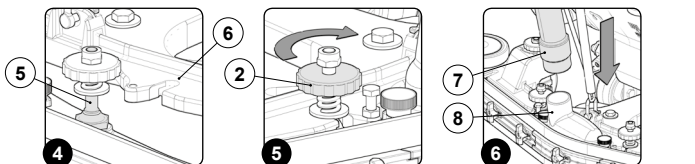

FILLING THE SOLUTION TANK WITH WATER

Before filling the solution tank, carry out the following steps:

1. Take the machine to the dedicated solution tank filling area.
2. Take all necessary steps to ensure that the device is in a safe condition (see "MACHINE SAFETY").
3. Check that the solution tank discharge cap (1) is open. If it isn't, open it (Fig.1).
4. Check that the filter plug of the water system (2) at the rear right part of the machine, has been tightened, and if not turn it clockwise (Fig.2).

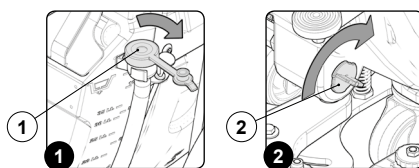

The solution tank can be filled with water in three different ways:

- Removing the cap/measuring device (3) and filling the solution tank by means of a rubber hose or a bucket (Fig.3).
 - Using the filler hose (4) (Fig.4). This supports the water hose on its own, but be sure to remove the cap/measuring device (3) to allow adequate air venting.
 - Using the optional system for automatic clean water top-up (5) (Fig.5). This system has a float for avoiding any overflow.
5. Fill with clean water, at a temperature not higher than 50°C and not lower than 10°C. The amount inside the tank can be seen by means of the level tube (6) (Fig.6) on the front left of the seat.

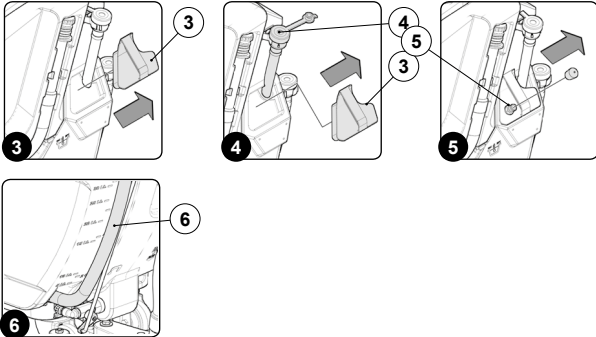

DETERGENT SOLUTION

After filling the solution tank with clean water add the liquid detergent to the tank in the concentration and manner indicated on the detergent manufacturer's label. To prevent the formation of an excessive amount of foam that could damage the vacuum motor, use the minimum percentage of detergent required.

- ATTENTION:** protective gloves should always be worn before handling detergents or acidic or alkaline solutions, to avoid serious injury to the hands.
- ATTENTION:** always use detergents whose manufacturer's label indicates their suitability for scrubbing machines. Do not use acid or alkaline products or solvents without this indication.
- ATTENTION:** Acid or alkaline maintenance detergent tank be used with pH values between 4 and 10 and that do not contain: oxidising agents, chlorine or bromine, formaldehyde, mineral solvents. The detergents used must be suitable for use with scrubbing machines.
- ATTENTION:** always use low-foam detergent. To avoid the production of foam, put a minimum quantity of anti-foam liquid in the recovery tank before starting to clean. Do not use pure acids.
- ATTENTION:** to make it easier to measure the detergent on the cap/measuring device, there are two notches indicating the two main detergent percentage quantities that can be used.

PREPARING TO WORK

Before beginning to work, it is necessary to:

1. Make sure that the recovery tank is empty, if not, empty it completely (see the paragraph "CHECKING AND CLEANING THE RECOVERY TANK").
2. Verify that the quantity of detergent solution in the solution tank is suitable for the type of work you wish to carry out, otherwise fill the solution tank (see the paragraph "FILLING THE SOLUTION TANK WITH WATER"). View the level tube (1) in the rear of the machine (Fig.1).
3. Make sure that the state of the squeegee rubbers is suitable for the work, if not, carry out maintenance (see the paragraph "CHECKING AND CLEANING THE SQUEEGEE BODY").
4. Make sure that the squeegee rubbers are in a working condition, if not, carry out maintenance (see the paragraph "CHECKING AND MAINTAINING THE SQUEEGEE BODY").
5. Make sure the water tap is fully open: the water adjustment knob (2) should be completely down (Fig.2).
6. Check that the solution tank discharge cap (3) is closed. If it isn't, open it (Fig.3).

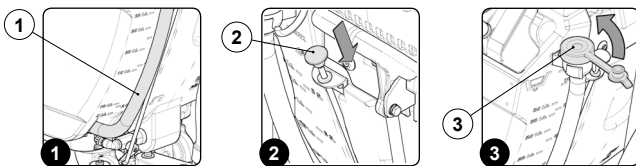

WORK

STARTING WORK (B versions)

To start working, do as follows:

1. Make all the checks listed in "PREPARING TO WORK".
2. Connect the plug on the power cable to the mains (Fig.1).
3. Get in the driving seat, behind the machine.
4. Set the main switch (1) to "ON - I" (Fig.2).

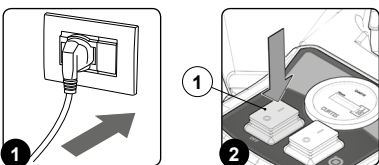

SCRUBBING WITH DRYING

To carry out "SCRUBBING AND DRYING" tasks, proceed as follows:

1. Carry out all the checks in the paragraph "STARTING WORK".
2. Lower the brush head body by pressing the brush head control pedal (1) on the back of the appliance (Fig.1).
3. Lower the squeegee body by means of the lever (2) on the back of the appliance (Fig.2).
4. By activating the dead man's lever (3), the machine will start to move (Fig.3).

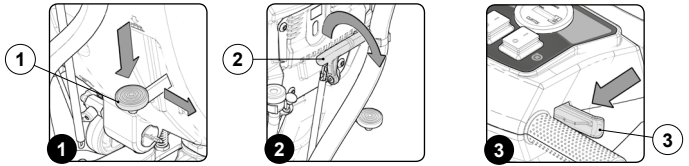

5. Start the vacuum motor, set the vacuum motor command switch (4) to "I" (Fig.4).
6. Check the detergent solution tap is fully open. If it isn't, turn the lever (5) on the back of the appliance (Fig.5).
7. During the first few meters, check that the detergent solution coming out is appropriate to the work to be carried out; if not, adjust it after reading the section "ADJUSTING DETERGENT SOLUTION".

The appliance will now begin to work with full efficiency until the battery is flat or until the detergent solution has finished. During the first few metres, check that there is sufficient solution and that the squeegee is drying correctly.

- ATTENTION:** if during the scrubbing - drying operation the dead man's lever is released, the brush motor and the solenoid valve will stop working, the vacuum motor will continue to work for a few seconds to ensure all the liquid in the vacuum hose is sucked up.
- ATTENTION:** when filling the solution tank, it is good practice to empty the recovery tank using the special drainage hose.
- ATTENTION:** by pulling the detergent solution flow adjustment knob downwards, the amount of solution in the water system will increase (Fig.5).

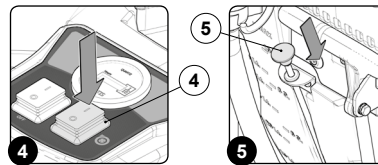

SCRUBBING WITHOUT DRYING

To carry out "SCRUBBING WITHOUT DRYING" tasks, proceed as follows:

1. Carry out all the checks in the paragraph "STARTING WORK".
2. Lower the brush head body by pressing the brush head control pedal (1) on the back of the appliance (Fig.1).
3. Lower the squeegee body by means of the lever (2) on the back of the appliance (Fig.2).
4. By activating the dead man's lever (3), the machine will start to move (Fig.3).
5. Check that the detergent solution tap is fully open. If it isn't, turn the lever (4) on the back of the appliance (Fig.4).
6. During the first few meters, check that the detergent solution coming out is appropriate to the work to be carried out; if not, adjust it after reading the section "ADJUSTING DETERGENT SOLUTION".

The appliance will now begin to work with full efficiency until the battery is flat or until the detergent solution has finished. During the first few metres, check that there is sufficient solution.

- ATTENTION:** if the dead man's lever is released during the scrubbing and drying operation, the brush motor and solenoid valve will stop working. To resume work, just press the dead man's levers.
- ATTENTION:** by pulling the detergent solution flow adjustment knob downwards, the amount of solution in the water system will increase (Fig.4).

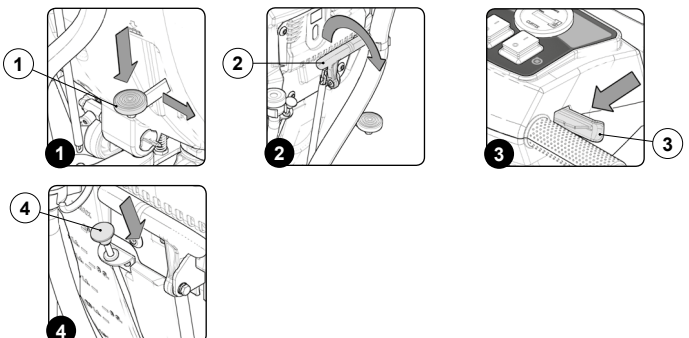

DRYING

To carry out "DRYING" tasks, proceed as follows:

1. Carry out all the checks in the paragraph "STARTING WORK".
2. Lower the squeegee unit by means of the lever (1) on the back of the appliance (Fig.1).
3. By activating the dead man's lever (2), the machine will start to move (Fig.2).
4. Start the vacuum motor, set the vacuum motor command switch (3) to "I" (Fig.3).

The machine will now work at its maximum efficiency level until the batteries run down.

ATTENTION: if the dead man's lever is released during the drying operation, the vacuum motor will continue working for another few seconds so that all the liquid in the vacuum hose can be removed.

The drying without scrubbing operation should only be carried out if beforehand the device was used to carry out scrubbing without drying.

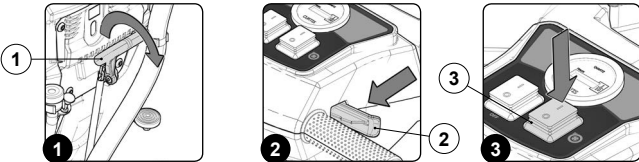

REGULATING THE DETERGENT SOLUTION

To adjust the amount of detergent solution on the brush, proceed as follows:

1. Fully open the flow from the tap on the back of the appliance by pulling the knob (1) on the back of the appliance downwards (Fig.1).
2. By pushing the dead man's lever (2) the brush motor will start operating and the solenoid valve will distribute detergent solution to the brush (Fig.2).
3. During the first few meters, check that the quantity of solution is enough to wet the floor, but not so much as to come out of the splash guard; the detergent disposal quantity can be adjusted by means of the knob (1) on the appliance's rear.

ATTENTION: If the water system does not work, see the paragraph "CHECKING AND CLEANING THE DETERGENT SOLUTION FILTER-CAP".

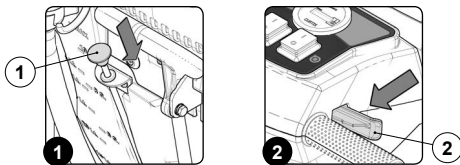

REGULATING THE FORWARD SPEED

The traction of this appliance is obtained by means of the brush which, working with the right weight distribution, is able to pull the appliance forwards. To regulate the forward speed, proceed as follows:

1. Adjust the forward speed by turning the knob (1) on the front of the appliance (Fig.1).

ATTENTION: turning the knob (1) clockwise tilts the brush forward, thus increasing the friction with the floor and thereby increasing the speed of the appliance.

ATTENTION: turning the knob (1) counter-clockwise tilts the brush backward, thus decreasing the friction with the floor and thereby decreasing the speed of the appliance.

2. Get in the driving seat, behind the machine.
3. Set the main switch (2) to "ON - I" (Fig.2).
4. Press the dead man's levers (3), positioned under the control handlebars (Fig.3).
5. Check that the adjustment carried out is as required, otherwise adjust the knob again (1).

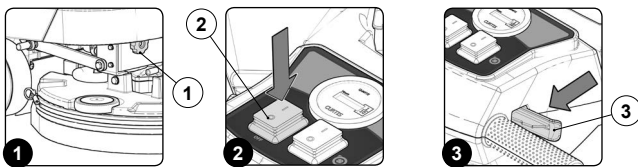

OVERFLOW DEVICE

The appliance is equipped with a mechanical device (float) under the recovery tank cap that, when the recovery tank is full, shuts off the air to the vacuum motor intake to protect it; the sound of the vacuum motor will then be deeper. If this is the case, proceed as follows:

1. Raise the brush head body off the floor by pressing the pedal (1) on the back of the appliance (Fig.1).
2. Switch off the vacuum motor, set the vacuum motor command switch (2) to "0" (Fig.2).
3. Raise the squeegee body off the ground using the lever (3) on the back of the appliance (Fig.3).
4. Switch off the appliance by setting the main switch (4) to "0" (Fig.4).
5. Take the appliance to the location intended for the discharge of dirty water and empty the recovery tank (see paragraph "RECOVERY TANK CONTROL AND MAINTENANCE" and "CONTROL AND MAINTENANCE OF THE RECOVERY TANK FILTER AND FLOAT SYSTEM").

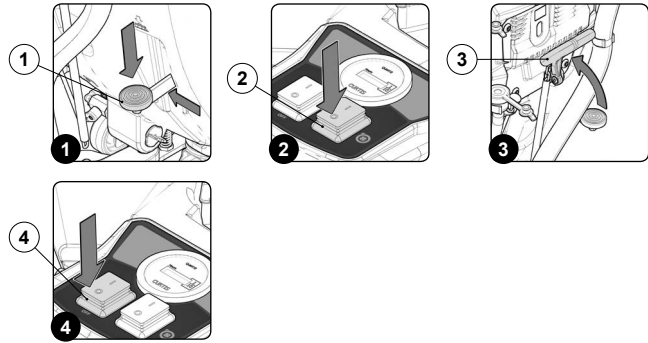

AT THE END OF THE WORK

At the end of the work, and before carrying out any type of maintenance, perform the following operations:

1. Raise the brush head body off the floor by pressing the pedal (1) on the back of the appliance (Fig.1).
2. Switch off the vacuum motor, set the vacuum motor command switch (2) to "0" (Fig.2).
3. Raise the squeegee body off the floor, using the lever (3) on the back of the appliance (Fig.3).
4. Switch off the appliance, setting the main switch (4) to "0" (Fig.4).
5. Take the appliance to the dedicated dirty water drainage area.
6. Carry out all the procedures listed in the paragraph "RECOMMENDED PERIODIC MAINTENANCE" indicated in the column "AT THE END OF THE WORK".
7. Take the appliance to the designated machine storage place.

ATTENTION: Park the appliance in an enclosed place, on a flat surface; near the appliance there must be no objects that could either damage it, or be damaged through contact with it.

8. Take all the necessary steps to ensure that the device is in a safe condition (see "MACHINE SAFETY").

ATTENTION: if the appliance is not used for more than a day, remove the brush from the brush head body (read the paragraph "CHECKING AND MAINTAINING THE BRUSH") and the squeegee support from the squeegee body (read the paragraph "CHECKING AND MAINTAINING THE SQUEEGEE BODY").

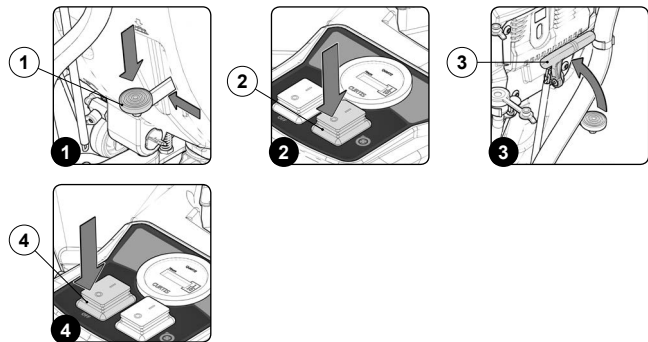

MAINTENANCE

RECOMMENDED MAINTENANCE OPERATIONS

| TYPE OF MAINTENANCE | AT THE END OF THE WORK | DAILY | WEEKLY | BEFORE A LONG PERIOD OF NON-USE | TRANSPORT |
|--|------------------------|-------|--------|---------------------------------|-----------|
| CHECKING AND CLEANING THE RECOVERY TANK | X | X | | X | X |
| CHECKING AND CLEANING THE SOLUTION TANK CAP-FILTER | X | X | | X | |
| CHECKING AND CLEANING THE SQUEEGEE BODY | | X | | X | |
| CHECKING AND CLEANING THE VACUUM HOSE | | X | | X | |
| CHECKING AND CLEANING THE RECOVERY TANK FILTER-FLOAT | X | X | | X | |
| CHECKING AND CLEANING THE SOLUTION TANK | | | X | X | X |
| CHECKING AND MAINTAINING THE BRUSH | | | X | X | |

CHECKING AND CLEANING THE RECOVERY TANK

Proceed as follows to empty the recovery tank:

1. Take the device to the dedicated maintenance area.
2. Take all necessary steps to ensure that the device is in a safe condition (see "MACHINE SAFETY").

ATTENTION: users are advised to always wear protective gloves, to avoid the risk of serious injury to hands.

3. Remove the drainage hose of the recovery tank from the clamps; it is located at the rear of the machine (Fig.1).
4. Bend the end of the drainage tube, so as to create a choke and prevent the content from coming out (Fig.2), put the tube on the discharge surface and gradually release the tube.

ATTENTION: the place designated for this operation must comply with current environmental protection regulations.

5. Grip the handle (1) on the back of the recovery tank cover and remove it (Fig.3).



6. With the recovery tank empty, rotate the recovery tank cover support (2). The optional support is positioned on the left side of the appliance (Fig.4).
7. Insert the clamp (3) of the recovery tank cover in the slot (4) on the recovery tank cover support (Fig.5).
8. Rinse the inside with a jet of water, if necessary use a spatula to remove the sludge that has accumulated at the bottom of the tank.
9. Repeat the operations in reverse order to reassemble all the parts.

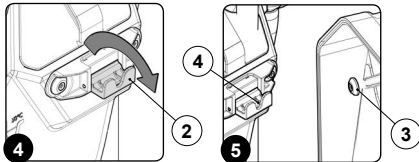

CHECKING AND CLEANING THE SOLUTION TANK CAP-FILTER

A thorough cleaning of the solution tank filter guarantees a longer life span of the appliance's water circuit system, ensuring a better floor cleaning performance. Proceed as follows to clean the solution tank's cap-filter:

1. Take the device to the dedicated maintenance area.
2. Take all necessary steps to ensure that the device is in a safe condition (see "MACHINE SAFETY").

ATTENTION: users are advised to always wear protective gloves, to avoid the risk of serious injury to hands.

3. Unscrew the detergent solution cap-filter (1), turning it counter-clockwise (Fig.1).
4. Clean it under a jet of clean water. Remove any impurities that may be present.

ATTENTION: the place designated for this operation must comply with current environmental protection regulations.

5. Repeat the operations in reverse order to reassemble all the parts.

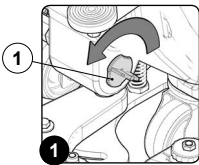

CHECKING AND CLEANING THE SQUEEGEE BODY

The careful cleaning of the whole vacuum unit ensures better drying and cleaning of the floor as well as a longer vacuum motor life. To carry out the cleaning of the squeegee body, proceed as follows:

1. Take the device to the dedicated maintenance area.
2. Take all necessary steps to ensure that the device is in a safe condition (see "MACHINE SAFETY").
3. Raise the squeegee body off the floor and press the squeegee body control lever (1) on the back of the device (Fig.1).

ATTENTION: these operations must be carried out using protective gloves to avoid any possible contact with the edges or tips of metal objects.

4. Remove the vacuum hose (2) from the vacuum nozzle (3) on the squeegee body (Fig.2).
5. Completely unscrew the knobs (4) in the squeegee body pre-assembly (Fig.3).

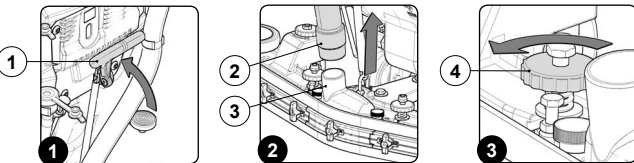

6. Remove the squeegee body from the slits in the squeegee connector (Fig.4).
7. Thoroughly clean the squeegee body vacuum chamber (5) with a jet of water, and then with a damp cloth (Fig.5).

ATTENTION: the place designated for this operation must comply with current environmental protection regulations.

8. Thoroughly clean the squeegee body front rubber blade (6) with a jet of water, and then with a damp cloth (Fig.6).

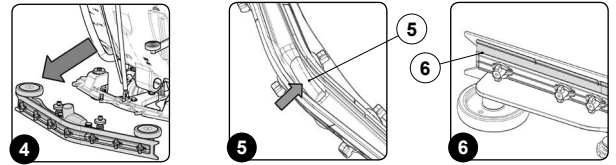

9. Thoroughly clean the squeegee body rear rubber blade (7) with a jet of water, and then with a damp cloth (Fig.7).

10. Unscrew the knobs (8) that fix the vacuum nozzle (3) to the squeegee body (Fig.8).
11. Remove the vacuum nozzle (3) from the squeegee body (Fig.8).
12. Thoroughly clean the vacuum nozzle (3) with a jet of water, and then with a damp cloth.
13. Also clean the support surface on the squeegee body (Fig.9).

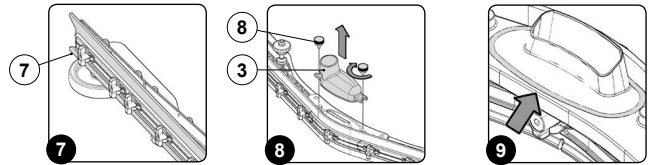

14. Position the vacuum nozzle (3) on the squeegee body and fix it in place by means of the knobs (8).
15. For refitting the squeegee body read the paragraph "ASSEMBLING THE SQUEEGEE BODY".

Check the wear of the front rubber blade on the squeegee body; if the edge of the rubber that is in contact with the floor is worn, replace it as follows:

1. Take the device to the dedicated maintenance area.
2. Take all necessary steps to ensure that the device is in a safe condition (see "MACHINE SAFETY").
3. Raise the squeegee body off the floor and press the squeegee body control lever (1) on the back of the device (Fig.1).

ATTENTION: these operations must be carried out using protective gloves to avoid any possible contact with the edges or tips of metal objects.

4. Remove the vacuum hose (2) from the vacuum nozzle (3) on the squeegee body (Fig.2).
5. Completely unscrew the knobs (4) in the squeegee body pre-assembly (Fig.3).
6. Remove the squeegee body from the slits in the squeegee connector (Fig.4).
7. Turn the wing nuts (9) to the horizontal position (Fig.10).
8. Remove the front rubber-pressing blades (10) (Fig.10).
9. Remove the rubber blade (11) and replace it (Fig.10).
10. Proceed in reverse to replace the rubber.

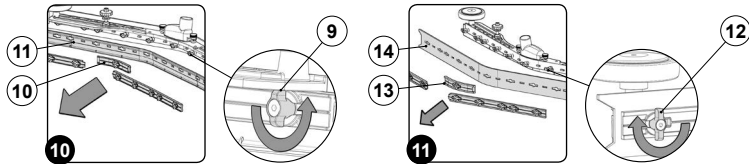

Check the wear of the rear rubber blade on the squeegee body; if the edge of the rubber in contact with the floor is worn, replace it (though the rubber can be turned onto another of its 4 edges) as follows:

1. Take the device to the dedicated maintenance area.
2. Take all necessary steps to ensure that the device is in a safe condition (see "MACHINE SAFETY").
3. Raise the squeegee body off the floor and press the squeegee body control lever (1) on the back of the device (Fig.1).

ATTENTION: these operations must be carried out using protective gloves to avoid any possible contact with the edges or tips of metal objects.

4. Remove the vacuum hose (2) from the vacuum nozzle (3) on the squeegee body (Fig.2).
5. Completely unscrew the knobs (4) in the squeegee body pre-assembly (Fig.3).
6. Remove the squeegee body from the slits in the squeegee connector (Fig.4).
7. Turn the wing nuts (12) to the horizontal position (Fig.11).
8. Remove the front rubber-pressing blades (12) (Fig.11).
9. Remove the rubber blade (14) and replace it (Fig.11).
10. Proceed in reverse to replace the rubber.

ADJUSTING THE SQUEEGEE BODY

Careful adjustment of the height between the squeegee rubber blades and the floor guarantees better drying and cleaning of the flooring as well as a longer vacuum motor life. To adjust the squeegee rubber blades, proceed as follows:

1. Take the device to the dedicated maintenance area.
2. Get in the driving seat, behind the machine.
3. Switch off the appliance by setting the main switch (1) to "ON - I" (Fig.1).
4. Lower the brush head body by pressing the brush head control pedal (2) on the back of the appliance (Fig.2).
5. Lower the squeegee body by means of the lever (3) on the back of the appliance (Fig.3).

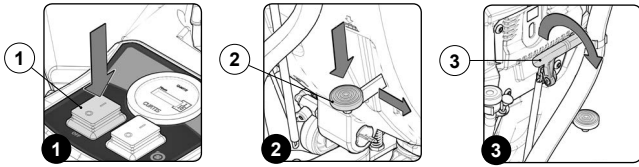

CHECKING AND CLEANING THE SOLUTION TANK

Proceed as follows to empty the solution tank:

1. Take the device to the dedicated maintenance area.
2. Take all necessary steps to ensure that the device is in a safe condition (see "MACHINE SAFETY").

ATTENTION: users are advised to always wear protective gloves, to avoid the risk of serious injury to hands.

3. Close the flow from the tap on the back of the appliance by pulling the tap command knob (1) on the back of the appliance upwards (Fig.1).
4. Remove the solution tank level tube from its seat (2), empty the solution tank (Fig.2).

ATTENTION: the place designated for this operation must comply with current environmental protection regulations.

ATTENTION: Before removing the solution tank level tube from its seat (2), close the drainage cap on the tube itself.

5. To facilitate the outflow of water from the solution tank, remove the solution tank water inlet cap (3) on the left side of the appliance (Fig.3).
6. Remove the solution tank drainage cap (4) from its seat, unscrewing it in the direction of the arrow (Fig.4).
7. Repeat the operations in reverse order to reassemble all the parts.

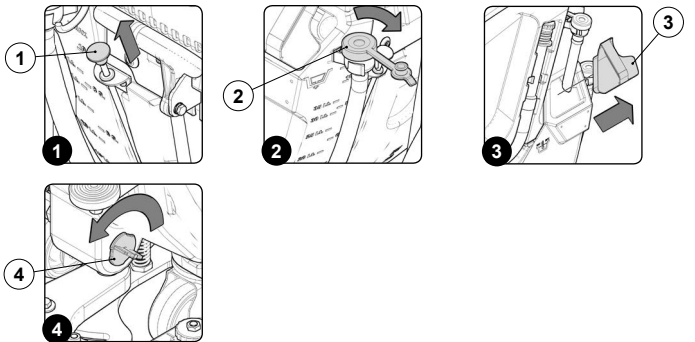

CHECKING AND MAINTAINING THE BRUSH

Careful cleaning of the brush guarantees better cleaning of the floor as well as a longer brush head gearmotor lifespan. To clean the brush, proceed as follows:

1. Take the device to the dedicated maintenance area.
2. Take all necessary steps to ensure that the device is in a safe condition (see "MACHINE SAFETY").

ATTENTION: users are advised to always wear protective gloves, to avoid the risk of serious injury to hands.

3. Raise the brush head body off the floor and press the brush head control pedal (1) on the rear of the device (Fig.1).
4. If the splash guard is present, release the retainer spring (2) on the brush head splash guards (Fig.2).
5. Remove the retainer blade (3) and the splash guard (4) (Fig.3).
6. With the brush head raised, turn it to extract the button from the coupling spring. The photo (Fig.4) shows the rotation direction for removing the brush.
7. If the splash guard is present, release the retainer spring (2) on the brush head splash guards (Fig.2).
8. Remove the retainer blade (3) and the splash guard (4) (Fig.3).
9. With the brush head UP, insert the brush in the plate housing underneath the brush head, turning it until the three buttons engage with the niches on the plate itself. Turn until the pin is pushed towards the coupling spring and is locked into place. The photo (Fig.4) shows the rotation direction for brush coupling.
10. Clean the brush under running water to remove any impurities from its bristles. Check that the bristles are not worn; in the event of excessive wear, replace the brush (the bristles should be at least 10 mm long). Read "ASSEMBLING THE BRUSH" to replace the brush.

ATTENTION: the place designated for this operation must comply with current environmental protection regulations.

11. Reassemble the splash guard (read "ASSEMBLING THE BRUSH HEAD SPLASH GUARD").

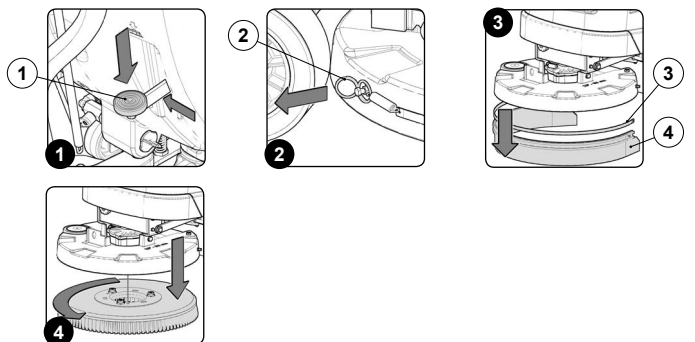

6. Adjust the detergent solution flow (read "ADJUSTING THE DETERGENT SOLUTION (VERSIONS WITHOUT CDS)" or "ADJUSTING THE DETERGENT SOLUTION (VERSIONS WITH CDS)")
7. By activating the dead man's lever (4), the machine will start to move (Fig.4).
8. During the first few metres of work, check that the squeegee rubber blades touch the floor evenly. If the rubber blade's tilt needs to be increased in the middle, tighten the screw (5) (Fig.5). To decrease its tilt, simply turn the screw (5) in the opposite direction.

ATTENTION: Loosen the locknut (6) before turning the screw (5). When finished, remember to secure the screw by tightening the locknut (6).

9. During working operation, the rear rubber blade should be slightly tilted backwards by about 30°- 45° with respect to the floor along its whole length. If you need to adjust the height of the rubber blades in relation to the floor, turn the knob (7) (the diagram only shows the left knob) counter-clockwise to raise the squeegee or clockwise to lower it (Fig.6).

ATTENTION: the right and left wheels must be adjusted to the same level, so the squeegee can work parallel to the floor.

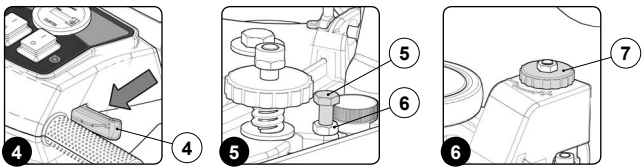

CHECKING AND MAINTAINING THE RECOVERY TANK FILTER-FLOAT

Careful cleaning of the recovery tank filter-float guarantees better cleaning of the floor as well as a longer vacuum motor lifespan. Proceed as follows to clean the recovery tank filter-float:

1. Take the device to the dedicated maintenance area.
2. Take all necessary steps to ensure that the device is in a safe condition (see "MACHINE SAFETY").

ATTENTION: users are advised to always wear protective gloves, to avoid the risk of serious injury to hands.

3. Grip the handle (1) on the back of the recovery tank cover and remove it (Fig.1).
4. Rotate the recovery tank cover support (2). The optional support is positioned on the left side of the appliance (Fig.2).
5. Insert the clamp (3) of the recovery tank cover in the slot (4) on the recovery tank cover support (Fig.3).

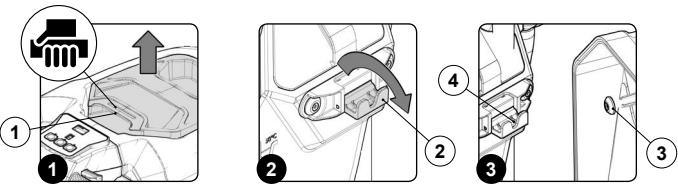

6. Remove the float cover (5), turning it in the direction of the arrow (Fig.4).
7. Remove the vacuum filter (6) and clean it (Fig.5).

ATTENTION: you are advised to use a jet of air to remove the impurities before cleaning the filter. Position the filter at least 20cm from the air jet.

ATTENTION: do not use highly corrosive products to clean the filter, to avoid damaging it.

8. Remove the upper part of the float (7), turning it in the direction of the arrow (Fig.6).

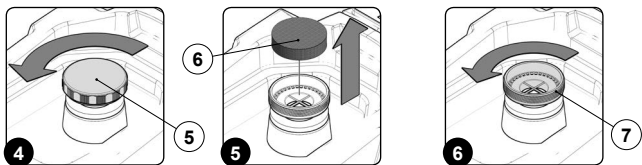

ATTENTION: when removing the upper part of the float, be very careful not to remove the lower part as well (8) (Fig.7).

9. Remove the float (9) (Fig.7). Rinse the inside with a jet of water. If necessary, use a spatula to remove the sludge that has accumulated at the bottom of the float.

ATTENTION: if the polyurethane ring (10) on the float (Fig.7) is damaged or excessively worn, contact your nearest assistance centre.

10. Repeat the operations in reverse order to reassemble all the parts.

CHECKING AND CLEANING THE VACUUM HOSE

Careful cleaning of the vacuum hose guarantees better cleaning of the floor as well as a longer vacuum motor life. Proceed as follows to clean the vacuum hose:

1. Take the device to the dedicated maintenance area.
2. Take all necessary steps to ensure that the device is in a safe condition (see "MACHINE SAFETY").

ATTENTION: users are advised to always wear protective gloves, to avoid the risk of serious injury to hands.

3. Remove the vacuum hose (1) from the vacuum nozzle (2) on the squeegee body (Fig.1).
4. Remove the vacuum tube (1) via the hole on the back of the recovery tank (Fig.2).
5. Remove the recovery tank drainage hose from the clamps.
6. Rinse the inside of the vacuum hose with a jet of running water.
7. Repeat the operations in reverse order to reassemble all the parts.

ATTENTION: Use particular caution when placing the vacuum hose behind the lifting chain, as indicated on the label (Fig.3).

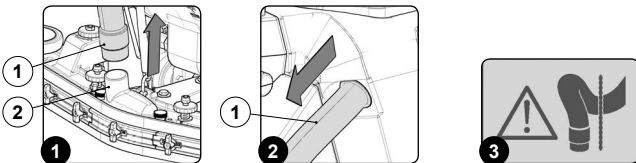

CLEANING THE WATER SYSTEM

Prior to any extended periods of disuse, do the following:

1. Take the device to the dedicated maintenance area.
2. Take all necessary steps to ensure that the device is in a safe condition (see "MACHINE SAFETY").

ATTENTION: users are advised to always wear protective gloves, to avoid the risk of serious injury to hands.

ATTENTION: the place designated for this operation must comply with current environmental protection regulations.

3. Make sure that the recovery tank is empty, if not, empty it completely (see the paragraph "CHECKING AND CLEANING THE RECOVERY TANK").
4. Verify that the quantity of detergent solution in the solution tank is suitable for the type of work you wish to carry out, otherwise fill the solution tank (see the paragraph "FILLING THE SOLUTION TANK WITH WATER"). View the level tube (1) in the rear of the machine (Fig.1).
5. Make sure the water tap is fully open; the water adjustment knob (2) should be completely down (Fig.2).
6. Set the main switch (3) to "ON - I" (Fig.3).

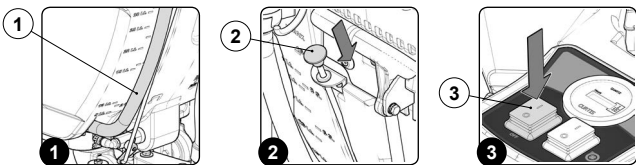

7. Lower the brush head body by pressing the brush head control pedal (4) on the back of the appliance (Fig.4).

ATTENTION: Do not bring the brush completely into contact with the floor.

8. When the dead man's lever (5) is engaged, the machine will start to move (Fig.5).
9. Wait a few minutes, normally 2 - 4 minutes, to allow the dosing system to be washed.

ATTENTION: the machine will dispense solution during this operation.

10. After these 2 - 4 minutes have passed, empty the solution tank completely (read the paragraph titled "CHECKING AND CLEANING THE SOLUTION TANK").

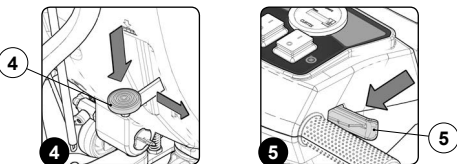

TROUBLESHOOTING

This chapter lists the most common problems linked with the use of the appliance. If you are unable to resolve the problems with the information given here, please contact your nearest assistance centre.

| PROBLEM | POSSIBLE CAUSE | SOLUTION |
|--|--|---|
| THE APPLIANCE DOES NOT SWITCH ON | The main switch is in the rest position. | Set the main switch to "ON - I". |
| | The plug on the appliance's power cable has not been correctly inserted into the mains socket. | Connect the plug on the appliance's power cable to the mains socket. |
| | The electrical specifications of the appliance do not match the electrical specifications of the power supply network. | Check that the technical data on the appliance's serial number plate match the data of the mains supply. |
| | The power cable is damaged. | Contact a specialised technician immediately. |
| | The line current fuse is damaged. | Change the line current fuse. |
| THE APPLIANCE DOES NOT PROCEED STRAIGHT. | The brush is not properly connected. | Connect the brush correctly. |
| | The brush head is not properly adjusted. | read paragraph "Brush head adjustment". |
| THE APPLIANCE DOES NOT MOVE | The dead man's levers are not activated. | Press the dead man's levers under the control handlebars. |
| INSUFFICIENT DETERGENT SOLUTION ON THE BRUSHES | The detergent solution tap is partially or completely closed. | Move the tap lever control knob downward. |
| | The quantity of detergent solution in the water system is not sufficient for the work to be carried out. | Check that the amount of detergent solution in the appliance's water system is right for the work to be carried out. |
| | Detergent solution filter obstructed. | Check that the detergent solution filter is not clogged, and if it is, clean it. |
| THE DEVICE DOES NOT CLEAN CORRECTLY | The appliance does not switch on. | Read the section "THE APPLIANCE DOES NOT SWITCH ON". |
| | Not enough detergent solution comes out. | Read the section "INSUFFICIENT DETERGENT SOLUTION ON THE BRUSHES". |
| | The brush is not correctly inserted in the appliance. | Check that the brush has been inserted correctly in the appliance. |
| | The type of brush used is not suitable for the dirt to be cleaned. | Check that the brushes on the appliance are adequate for the work to be carried out. |
| | The brush bristles or the pad are excessively worn. | Check the state of wear of the brush and, if necessary, replace it. |
| | Brush head motor thermal circuit-breaker active. | To supply the motor with current it is necessary to switch off the machine and wait until it cools down. |
| THE SQUEEGEE DOES NOT DRY PERFECTLY | | Check that the squeegee has no obstructions. |
| | The vacuum unit is obstructed. | Check that the vacuum hose has no obstructions. Check that the vacuum filter cap has no obstructions. |
| | The cap on the recovery tank drainage tube is not properly positioned. | Check that the cap on the recovery tank drainage tube is positioned properly. |
| | The recovery tank cover is not positioned correctly. | Check that the recovery tank cover is properly positioned on the appliance. |
| EXCESSIVE FOAM PRODUCTION | The detergent being used is not suitable. | Check that a low foam detergent has been used. If necessary, add a small quantity of anti-foam liquid to the recovery tank. |
| | The floor is not very dirty. | Dilute the detergent more. |
| THE DEVICE DOES NOT VACUUM CORRECTLY | The recovery tank is full. | Empty the recovery tank. |
| | The vacuum unit is obstructed | Read the section "THE SQUEEGEE DOES NOT DRY PERFECTLY". |